

Turmdrehkran 34 K

Tower Crane / Grue à tour / Gru a torre / Grúa torre
Guindaste de torre / Башенный поворотный кран

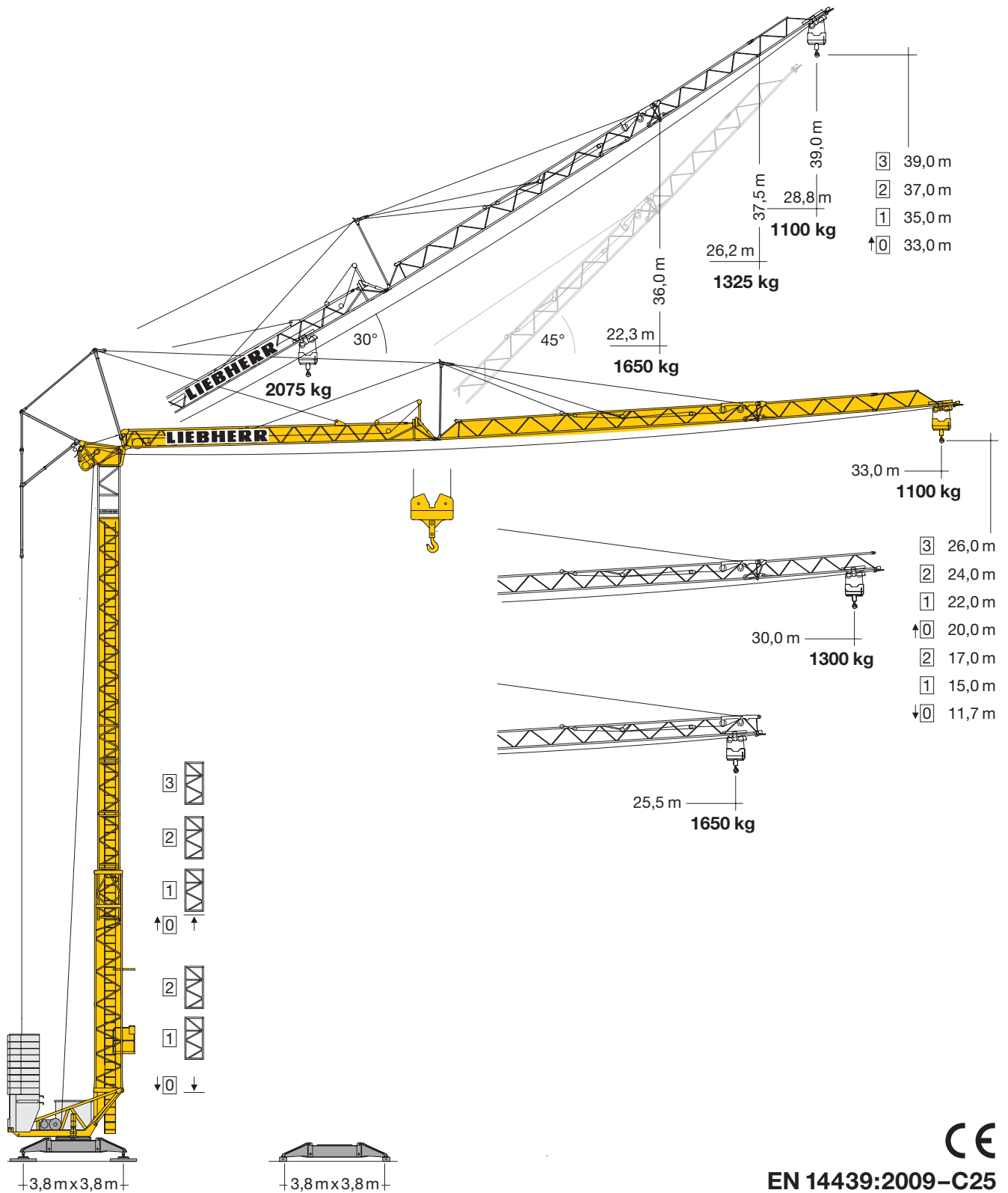

EN 14439:2009-C25

LIEBHERR

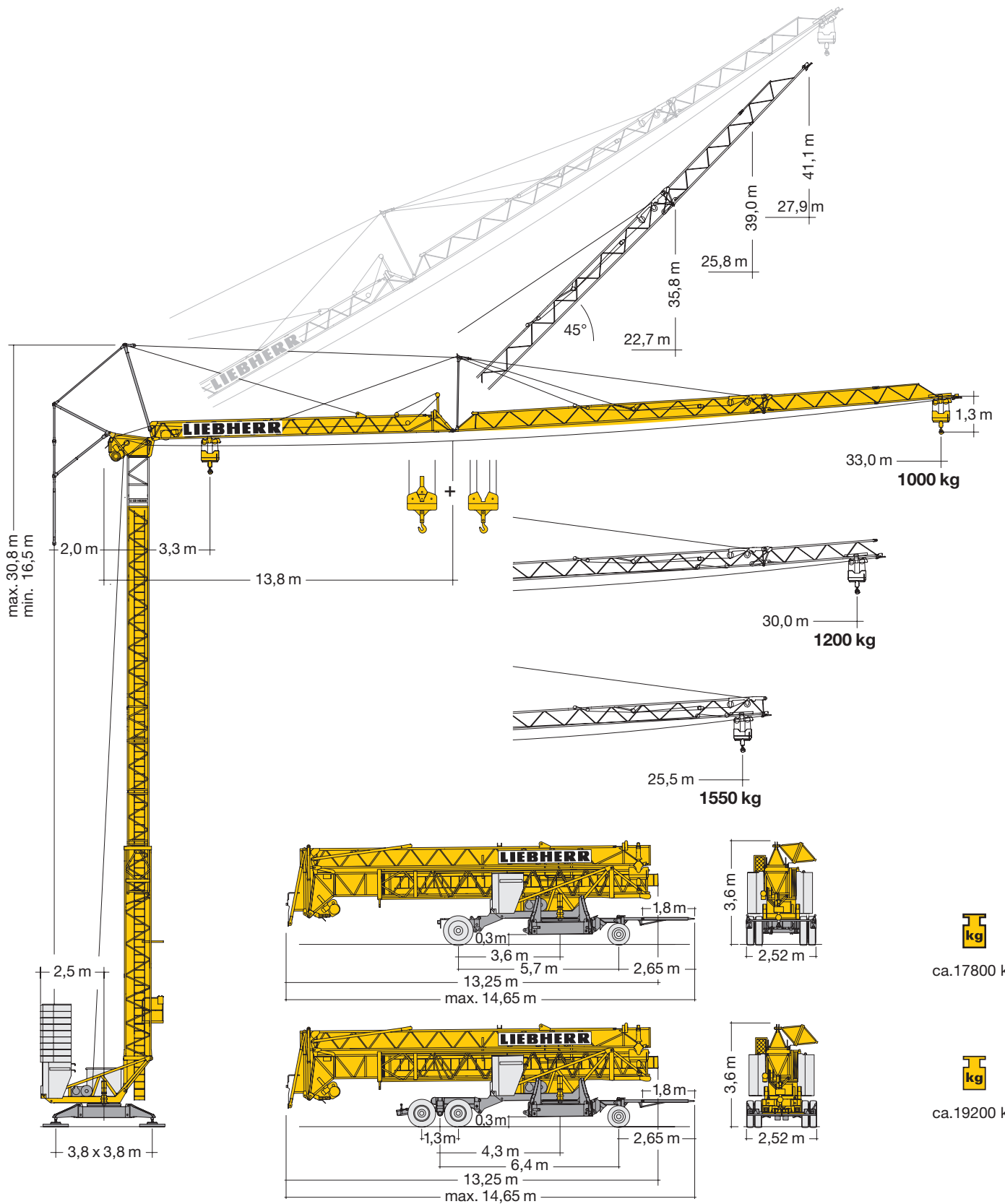

Gewicht Weight / Poids / Peso / Pesos / Macca

	$r = 2,5 \text{ m}$	18980 kg		ca. 10400 kg (26 m: + 1050 kg)
--	---------------------	----------	--	-----------------------------------

Ausladung und Tragfähigkeit

Radius and capacity / Portée et charge / Sbraccio e portata
Alcances y cargas / Alcance e capacidade de carga / Вылет и грузоподъемность

m	max. kg m/kg	m/kg																							
		10,0	11,0	12,0	13,0	14,0	15,0	16,0	17,0	18,0	19,0	20,0	21,0	22,0	23,0	24,0	25,5	26,0	27,0	28,0	29,0	30,0	31,0	32,0	33,0
33,0	3,3 - 17,40 2075	2075	2075	2075	2075	2075	2075	2075	2075	1990	1870	1750	1650	1560	1480	1410	1310	1275	1220	1160	1120	1100	1100	1100	1100
30,0	3,3 - 18,40 2075	2075	2075	2075	2075	2075	2075	2075	2075	2075	2000	1880	1770	1680	1590	1510	1400	1370	1310	1300	1300	1300	1300	1300	1300
25,5	3,3 - 19,50 2075	2075	2075	2075	2075	2075	2075	2075	2075	2075	2075	2010	1890	1790	1700	1650	1650								

m	max. kg m/kg	m/kg																							
		10,0	11,0	12,0	13,0	14,0	15,0	16,0	17,0	18,0	19,0	20,0	21,0	22,0	23,0	24,0	25,5	26,0	27,0	28,0	29,0	30,0	31,0	32,0	33,0
33,0	3,3 - 17,06 2000	2000	2000	2000	2000	2000	2000	2000	2000	1870	1750	1640	1540	1450	1370	1300	1200	1170	1110	1060	1010	1000	1000	1000	1000
30,0	3,3 - 18,10 2000	2000	2000	2000	2000	2000	2000	2000	2000	2000	1880	1770	1660	1560	1480	1400	1300	1270	1210	1200	1200	1200	1200	1200	1200
25,5	3,3 - 19,19 2000	2000	2000	2000	2000	2000	2000	2000	2000	2000	1900	1790	1690	1600	1550	1550									

m	max. kg m/kg	m/kg																							
		10,0	11,0	12,0	13,0	14,0	15,0	16,0	17,0	18,0	19,0	20,0	21,0	22,0	23,0	24,0	25,5	26,0	27,0	28,0	29,0	30,0	31,0	32,0	33,0
33,0	3,3 - 9,91 4000	3950	3490	3120	2820	2570	2350	2170	2010	2000	2000	1890	1780	1680	1590	1510	1400	1360	1300	1240	1180	1130	1090	1040	1000
30,0	3,3 - 10,46 4000	4000	3750	3350	3030	2760	2530	2400	2400	2280	2130	2000	1880	1780	1680	1590	1510	1440	1370	1310	1250	1200	1200	1200	1200
25,5	3,3 - 11,04 4000	4000	4000	3600	3250	3100	2990	2760	2560	2390	2230	2100	1970	1860	1760	1670	1550								

m	max. kg m/kg	Auslegersteilstellung 30° / Elevated jib 30° / Flèche inclinée 30° / Braccio inclinato a 30° / Pluma inclinada 30° / Lança inclinada 30° / Положение стрелы под углом 30°																							
		16,0	17,0	18,0	19,0	20,0	21,0	22,3	23,0	24,0	25,0	26,2	27,0	28,0	28,8										
33,0	3,0 - 16,48 2075	2075	2000	1850	1730	1620	1520	1400	1350	1280	1210	1140	1100	1100	1100	1100	1100	1100	1100	1100	1100	1100	1100	1100	1100
30,0	3,0 - 17,15 2075	2075	2075	1950	1820	1710	1600	1480	1430	1350	1325	1325	1325	1325	1325	1325	1325	1325	1325	1325	1325	1325	1325	1325	1325
25,5	3,0 - 17,76 2075	2075	2075	2040	1910	1790	1680	1650	1650	1650	1650	1650	1650	1650	1650	1650	1650	1650	1650	1650	1650	1650	1650	1650	1650

Antriebe

Driving units / Mécanismes d'entraînement / Meccanismi / Mecanismos / Mecanismos / Приводы

	U/min. sl./min tr./min 0 ↔ 0,9	2,2 kW EDC
	20,0 / 40,0 m/min	1,3 / 2,3 kW
	25,0 m/min	2 x 1,3 kW
	0 - 45° ca. 30 sec.	2,2 kW

	Stufe / Step / Cran / Marcia Velocidad / Velocidade Передача	kg	m/min
11,0 kW	1	2075	6,0
	2	2075	25,0
	3	1075	50,0
11,0 kW	1	2000 4000	6,0 3,0
	2	2000 4000	25,0 12,5
	3	1000 2000	50,0 25,0
11,0 kW FU	1	2000 4000	3,0 1,5
	2	2000 4000	30,0 15,0
	3	1500 3000	40,0 20,0
	4	1000 2000	55,0 27,5





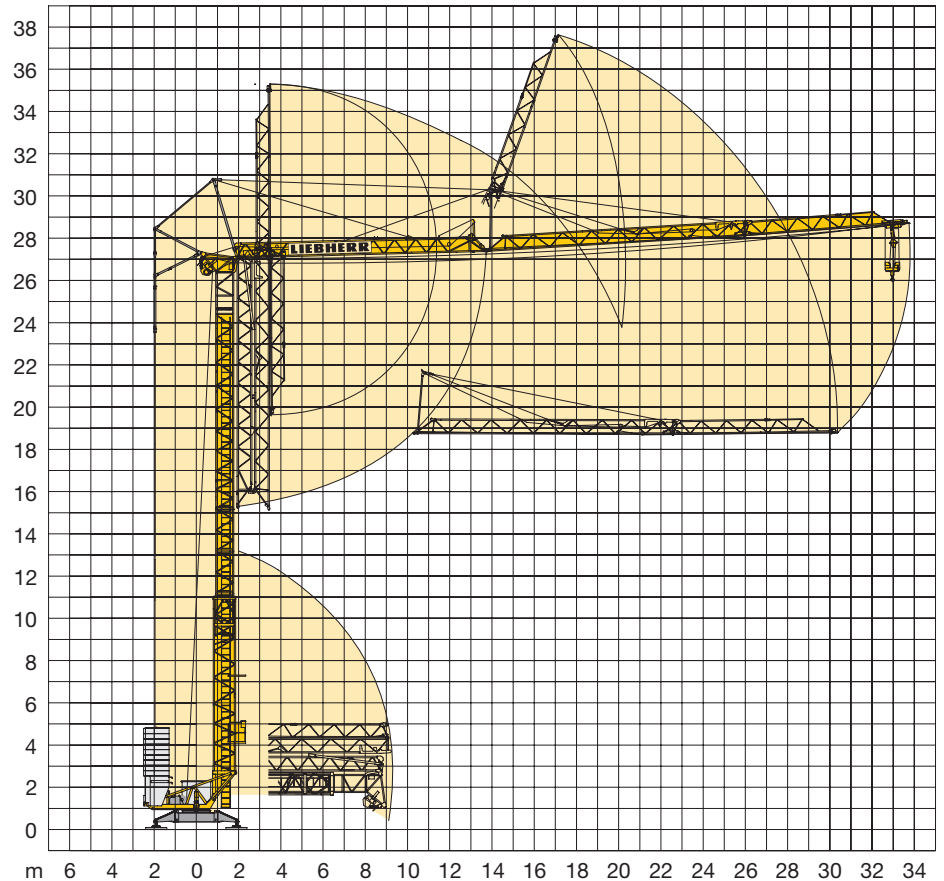



BGL		C.0.08.0040		C.0.08.035,5
-----	--	-------------	--	--------------

	400 V	Hz	kVA
78,0 m	4 x 6 mm ² KL 4 x 6 mm ² FU	50	22,0 KL 17,0 FU

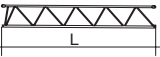

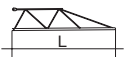
Kolli-Liste

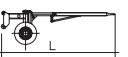
Packing List / Liste de colisage / Lista dei colli
Lista de contenido / Lista de embalagem / Упаковочный лист

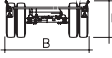
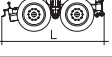
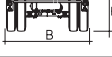
Pos. Item Rep Voce Pos. Ref. Pos.	Anz. Qty. Qte. Qta. Cant. Cant. Кол-во				L (m)	B (m)	H (m)	kg	
1	3	Turmstück / Tower section / Elément de mât / Elemento di torre / Tramo de torre / Peça de torre / Башенная секция			2,10	0,85	0,88	350	
2	1	Ausleger-Verlängerung 25,5 m – 30,0 m Jib extension / Rallonge de la flèche / Elemento estensione braccio / Prolongación de pluma Extensão da lança / Удлинение стрелы			4,70	0,80	0,70	180	
3	1	Ausleger-Verlängerung 30,0 m – 33,0 m Jib extension / Rallonge de la flèche / Elemento estensione braccio / Prolongación de pluma Extensão da lança / Удлинение стрелы			3,10	0,80	0,70	65	
4	1	Transportachse vorne / Road transport axle front Essieux de transport avant / Asse di trasporto anteriore Eje delantero para transporte / Eixo de transporte dianteiro / Транспортировочная ось, передняя	Tra 100 KY 2 Tra 100 KY 6 Tra 100 KY 6 A			3,65 – 4,15	1,45	1,10	750 920 920
5	1	Transportachse hinten / Road transport axle behind Essieux de transport arrière / Asse di trasporto posteriore Eje trasero para transporte / Eixo de transporte traseiro / Транспортировочная ось, задняя	Tra 120 GY 1 A Tra 120 GY 1			1,90	2,50	1,05	1100
6	1	Transportachse Tra 204 / Road transport axle / Essieux de transport / Assali par trasporto / Eje de transporte Eixo de transporte / Транспортная ось				3,10	2,50	1,10	1900
7	1	Kiste mit Seilen und Kleinteilen / Case with ropes and small parts Caisse avec câbles et pièces détachées / Cassa con funi e accessori Caja con cables y piezas sueltas / Caixa contendo cabos e acessórios Ящик с мелкими деталями и с канатами			1,00	0,80	1,00	450	

Konstruktionsänderungen vorbehalten! / Subject to alterations! / Sous réserves de modifications! / Riservato il diritto di modifiche strutturali!
¡Sujeto a modificaciones! / Salvo modificação da construo! / Права на внесение конструкторских изменений сохраняются!

Sämtliche Angaben erfolgen ohne Gewähr. / This information is supplied without liability. / Ces renseignements sont sans garantie. / Tutte le indicazioni fornite senza garanzia. / Declinamos toda responsabilidad derivada de la información proporcionada. / Declinamos qualquer responsabilidade quanto à informação fornecida. / Все данные указаны без обязательств.

120 P – 5808 • EN 14439:2009 – DIN 15018-H1/B3 • BGL C.0.08.0040 • 01.10 / 7

Printed in Germany.